



CITY

60076



 [LEGO.com/city](https://www.lego.com/city)



1



2



3



4



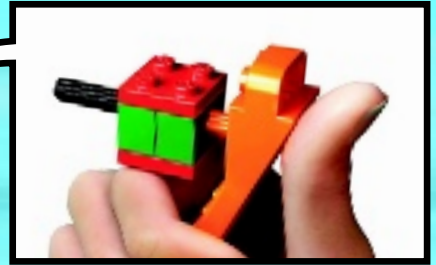

LEGO.com/brickseparator



1

1



2



3



4



2

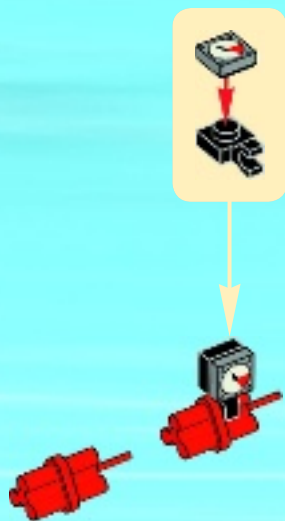

3

1



2



3



4

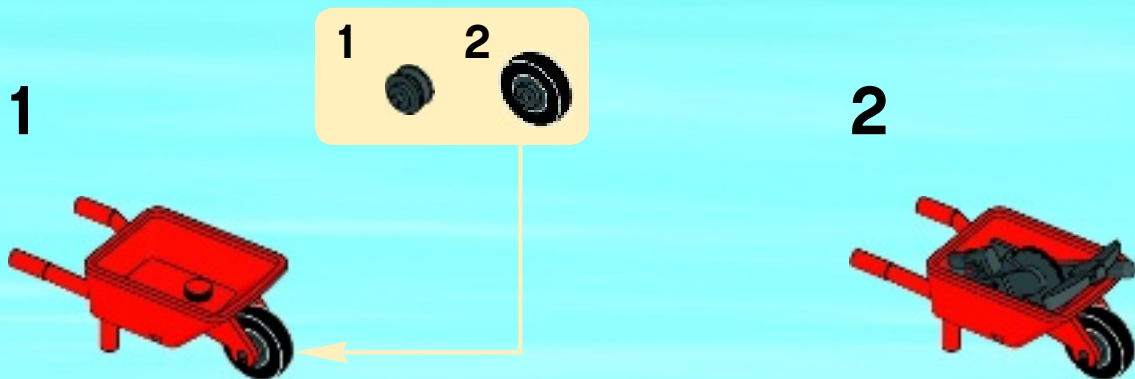



1x

1





1x

2



1x



1x

3





1x



2x

4





1x

5

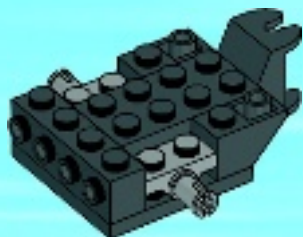

1x

6

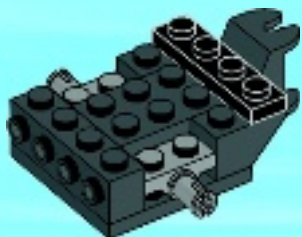



1x

7





8

1



2

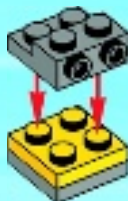

3



4







2x

9



2x



1x

10





1x



1x

11





1x

12



1x



1x

13



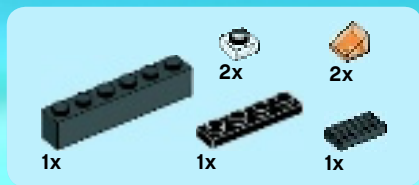

14

1

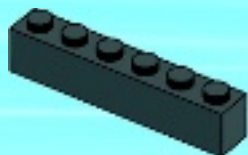

2

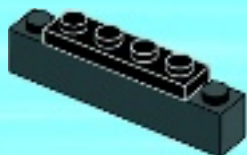

3



4





2x

15

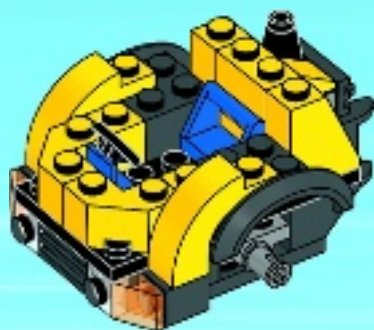



2x

16



2x

17

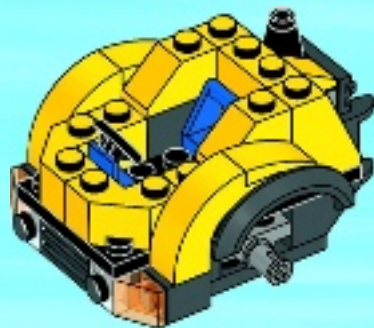



1x



1x

18

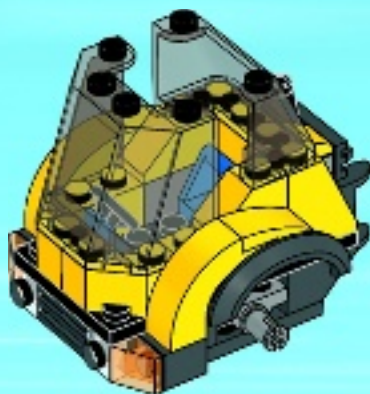



1x



1x

19

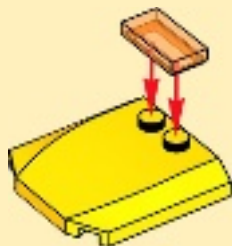
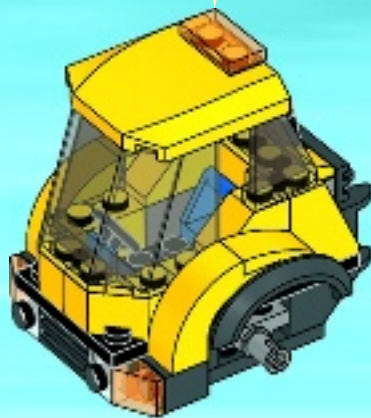



1x

1



1x



1x

2





1x

3

1

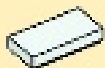

2

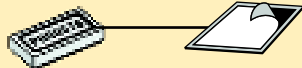



1x



1x

4

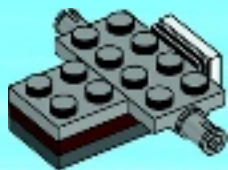



2x



1x

5



1x

6





2x



1x

7

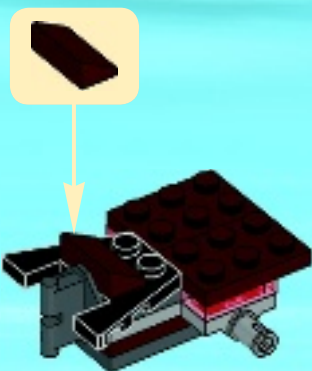

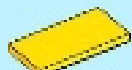

1x

8

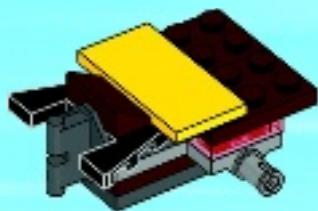

2x

9

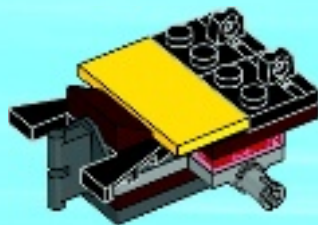



1x

10





1x

11

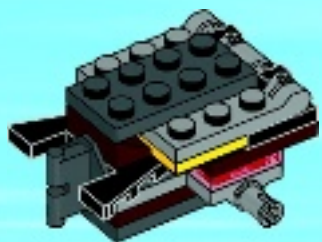

2x



2x

12





2x

13

1

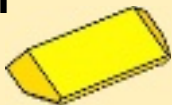

2



2x



14

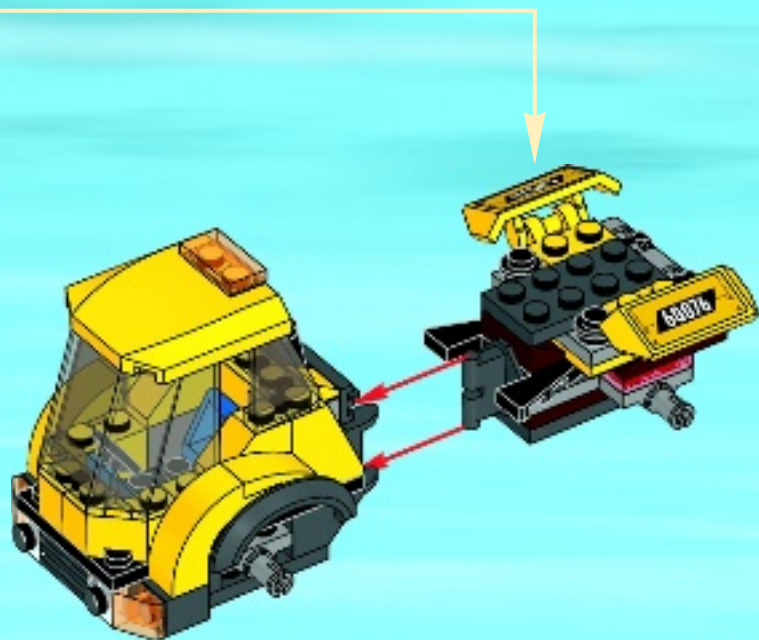



4x



4x

15



4x

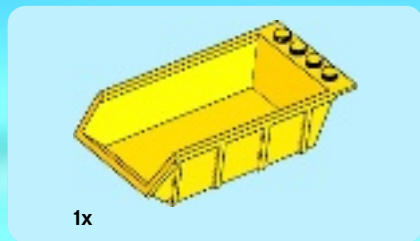

16

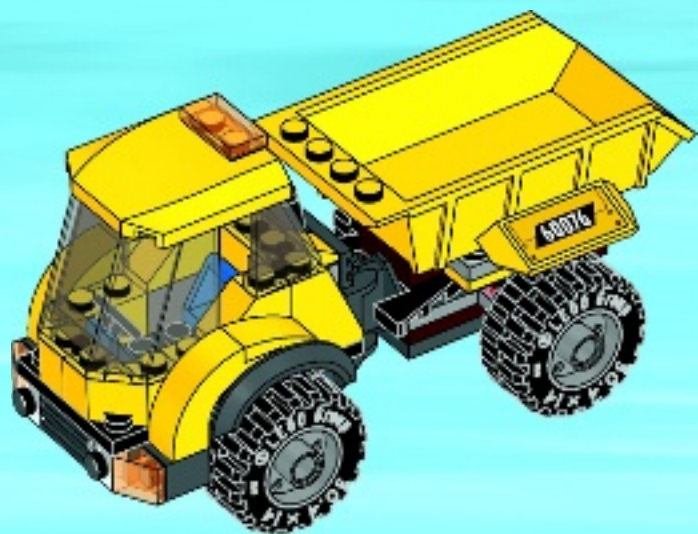



6x



4x

17

